



GENERAL PURPOSE AUGERS

**Selection,
Innovation,
Performance**

Your One-Stop Shop
for Hydraulic Tools
and Attachments





WARNING

WARNING



PENGO®

Pengo® Signature tools have been on the jobsite since 1950. Over this period Pengo has provided countless drilling solutions and introduced over 70 ground breaking patents and industry leading innovation.

The original Pengo Earth Auger was developed by Peterson Engineering Company for use in their “Transmission Line Construction Department”, this pioneering auger was created based on the need to drill what was known as “impossible ground conditions”.

AUGER SOIL CHART

Pengo has developed the below chart to help you decide which auger will be best suited for your project. The above triangles and color guide will be included with all products where applicable.



DIRT



SAND



SILT



CLAY



GRAVEL



FRACTURABLE
ROCK



NON-FRACTURABLE
ROCK

1	dirt; peat, organic silts, very loose sand, very soft, swamp, marsh	soil abrasion: low
2	sand; loose, fine sand; loess and medium clay, flood plain soils, lake clay	soil abrasion: medium
3	silt; coarse sand to stiff clay, dense hydraulic fill, compacted fill, residual soils	soil abrasion: high
4	clay; stiff to very stiff clay, glacial till, hard-pan, marls	soil abrasion: low to medium
5	gravel; basalt, very hard silts and clay, weathered laminated rock	soil abrasion: high
6	fracturable rock; caliche, coarse gravel and cobbles; frozen soil	soil abrasion: high
7	non-fracturable rock; granite, basalt, massive limestone	soil abrasion: high

GENERAL PURPOSE AUGERS

Pengo will commonly refer to the "parts" of the auger to help determine which one is suitable to your needs. Please use the diagram to the right as a reference guide when determining out the auger you would like quoted.

PRIME MOVER COMPATIBILITY

CARRIER	AUGER(S) COMPATIBLE
 CTC, Mini Skid Steer	Landscape Aggressor®
 Skid Steer	Aggressor®, Tree Aggressor®, TriMax®, Severe Rock Ripper®
 Mini Excavator	Aggressor®, Tree Aggressor®, TriMax®, Severe Rock Ripper®
 Backhoe	Aggressor®, Tree Aggressor®, TriMax®, Severe Rock Ripper®

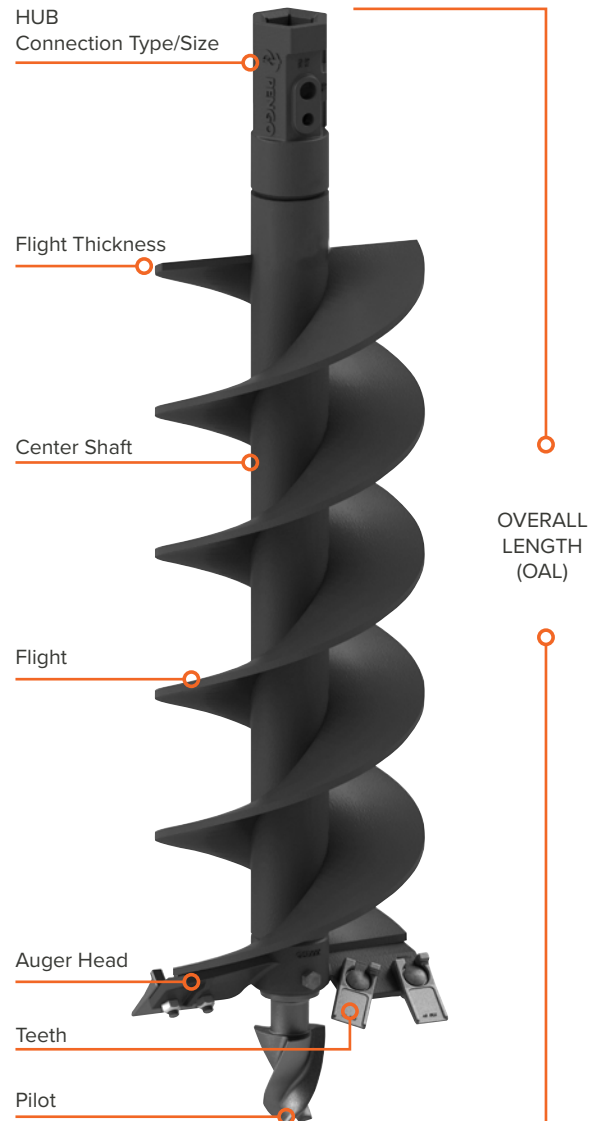

LANDSCAPE AGGRESSOR® AUGER

Pengo's Landscape Aggressor® is the perfect tool for landscaping applications or where smaller machines are required. Shorten flight bodies offers substantial weight reduction and performance is enhanced with our double entry flight design. Paired with our TriFlow® 350 pilot, providing three drill points for longer wear, the Landscape Aggressor provides big performance in a small package.

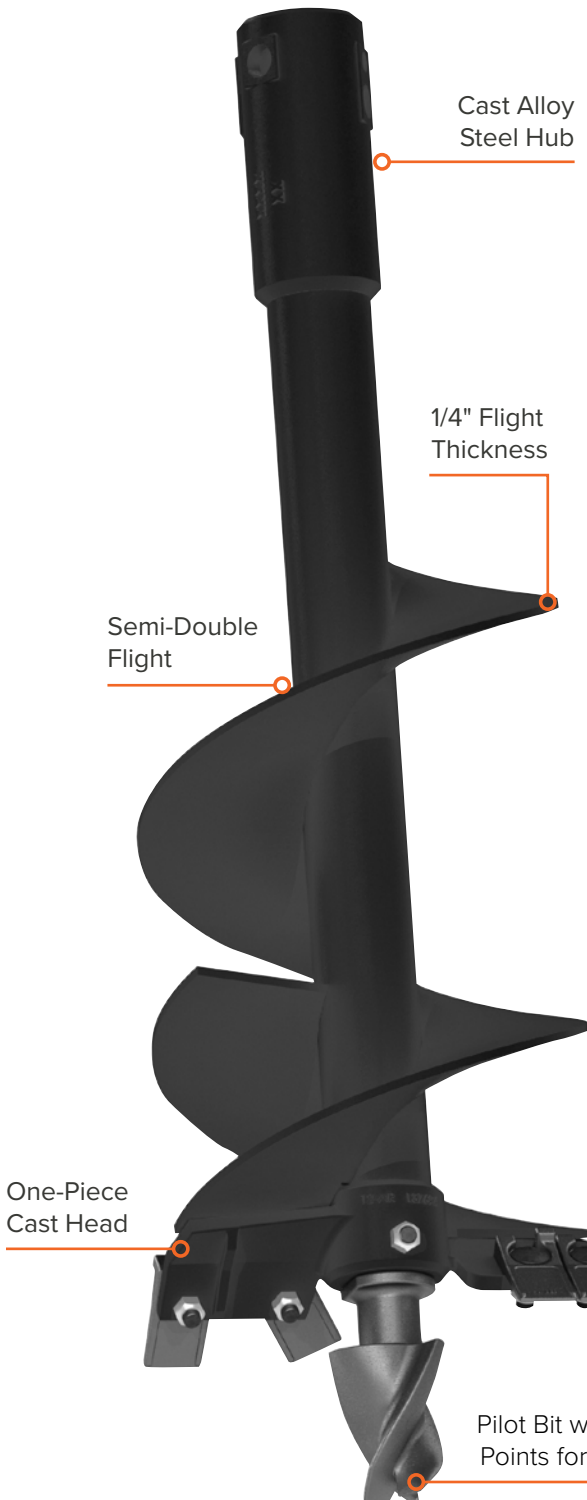

DRILLING SOIL CONDITIONS

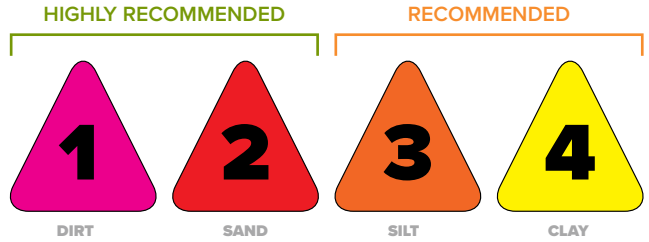

2" ROUND - 30" OAL

ITEM	DIA	NO. TEETH	LBS	PN
6-MA-30	6"	2	35	138400
9-MA-30	9"	4	42	138405
12-MA-30	12"	4	48	138410

2" ROUND - 48" OAL

ITEM	DIA	NO. TEETH	LBS	PN
6-MA-48	6"	2	50	138010
9-MA-48	9"	4	58	138011
12-MA-48	12"	4	68	138012
15-MA-48	15"	5	78	138013
18-MA-48	18"	6	85	138014

The Landscape Aggressor® Auger item numbers are for standard augers only. These augers will be shipped with standard teeth and pilot. You may order additional upgraded wear parts to enhance the drilling capabilities of your auger.

40°/50° Dual Angle
Teeth with 3-Point
Lock & Bolt Fasteners



TriFlow® 350
Pilot Bit with Three Drill
Points for Longer Wear

AGGRESSOR® AUGER

Pengo's Aggressor® Auger is the standard in which all others are measured, a professional grade tool designed for daily and constant use. The patented Tri-Flow pilot provides unmatched auger stability as well as up to 50% longer wear over conventional pilot bits. Double flight technology provides maximum spoil removal and the 5/16" flight thickness provides the long term durability demanded for daily use.

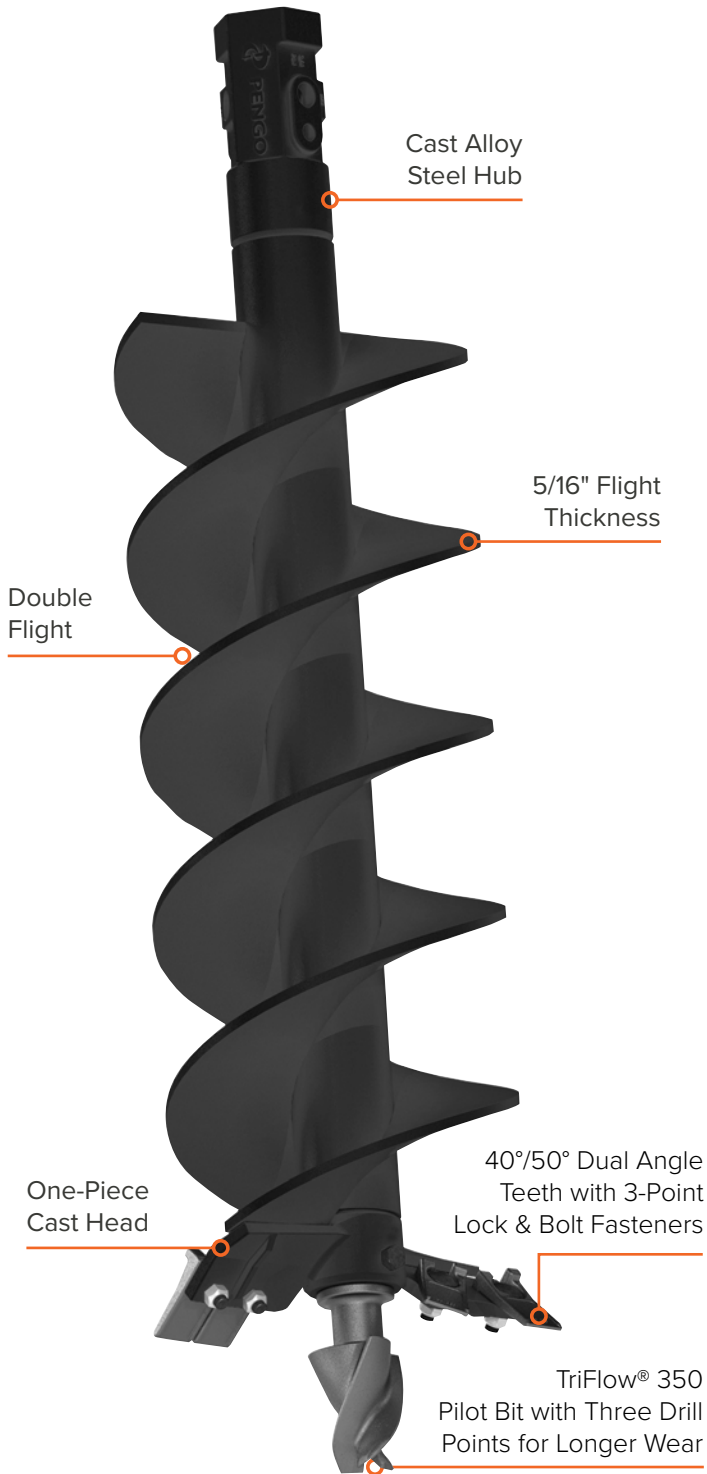

DRILLING SOIL CONDITIONS

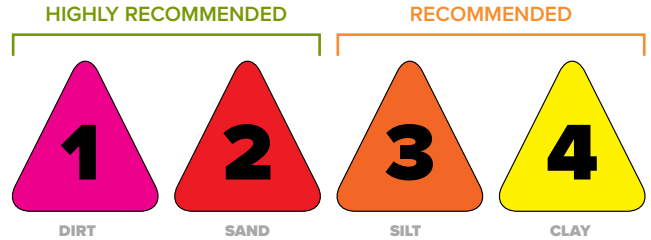

2" HEX - 36", 49", & 51" OAL

ITEM	DIA	NO. TEETH	LBS	PN
6-AR-36	6"	2	39	236011
9-AR-36	9"	4	55	236012
12-AR-36	12"	4	68	236013
15-AR-36	15"	5	73	236014
18-AR-36	18"	6	70	236015
6-AR-49	6"	2	54	PNG104152
9-AR-49	9"	4	78	PNG104153
12-AR-51	12"	4	114	PNG104154
15-AR-51	15"	5	117	PNG104155
18-AR-51	18"	6	145	PNG104156
24-AR-51	24"	8	210	PNG104157
30-AR-51	30"	10	225	PNG104158
36-AR-51	36"	12	295	PNG104159

2 9/16" ROUND - 36", 49", & 51" OAL

ITEM	DIA	NO. TEETH	LBS	PN
6-AR-36	6"	2	37	236016
9-AR-36	9"	4	54	236017
12-AR-36	12"	4	66	236018
15-AR-36	15"	5	72	236019
18-AR-36	18"	6	69	236020
6-AR-49	6"	2	54	PNG104168
9-AR-49	9"	4	78	PNG104169
12-AR-51	12"	4	114	PNG104170
15-AR-51	15"	5	117	PNG104171
18-AR-51	18"	6	145	PNG104172
24-AR-51	24"	8	210	PNG104173
30-AR-51	30"	10	225	PNG104174
36-AR-51	36"	12	295	104175

AGGRESSOR® TREE AUGER

Pengo's Aggressor® tree auger is a more robust version of our Landscape Aggressor Tree Auger and made specifically for high-duty cycle applications. Offering the same two-stage design that produces a tailored fit for the root ball, the Aggressor also offers the options of a 2" hex connection and the ability to change the pilot and teeth to accommodate light rock and permafrost soil conditions.

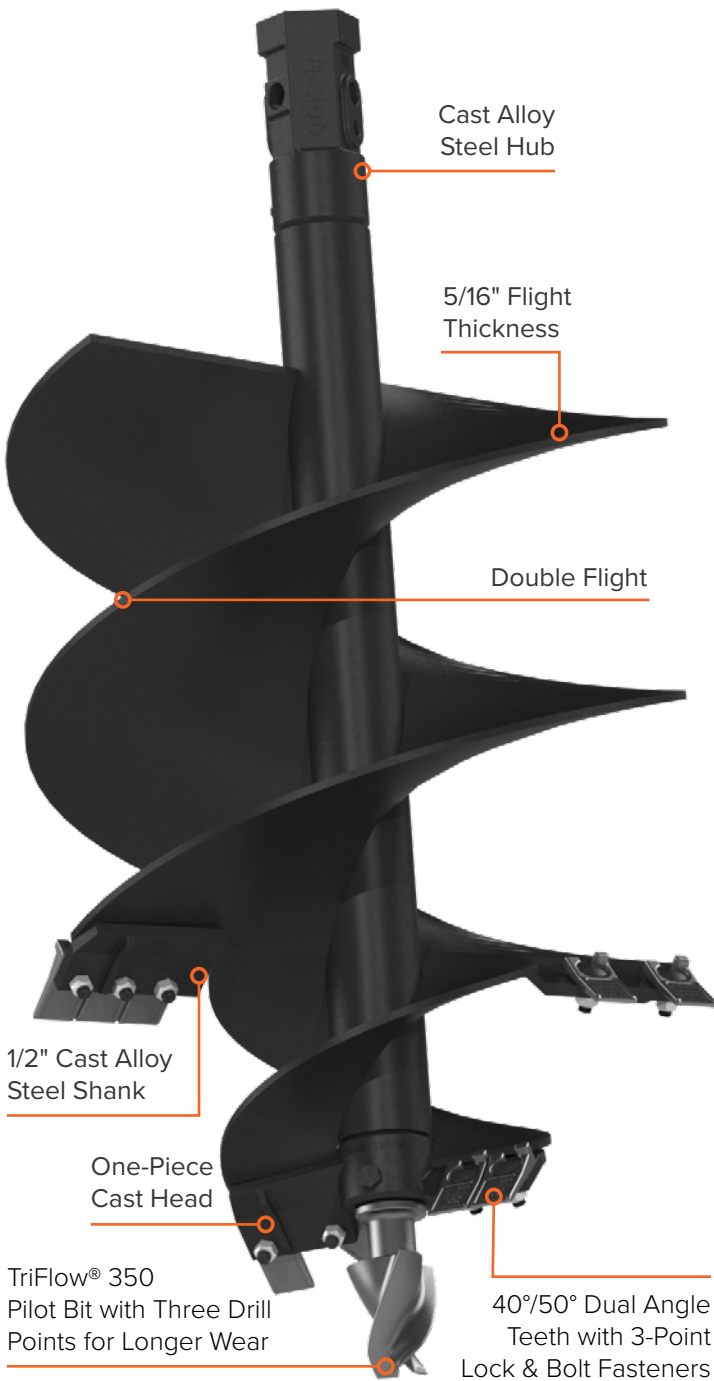

DRILLING SOIL CONDITIONS

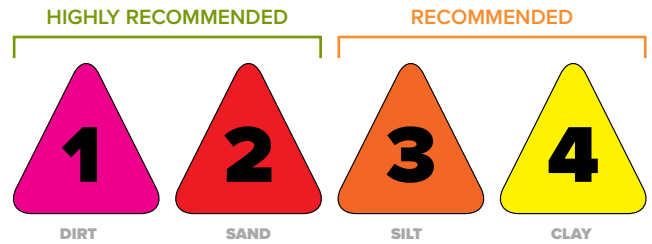

2 9/16" ROUND - 51" OAL

ITEM	START DIA	END DIA	NO. TEETH	LBS	PN
918-AR-51	9"	18"	8	155	135542
1224-AR-51	12"	24"	9	160	135543
1530-AR-51	15"	30"	11	255	135544
1836-AR-51	18"	36"	13	290	135545

2" HEX - 51" OAL

ITEM	START DIA	END DIA	NO. TEETH	LBS	PN
918-AR-51	9"	18"	8	155	135554
1224-AR-51	12"	24"	9	160	135555
1530-AR-51	15"	30"	11	255	135556
1836-AR-51	18"	36"	13	290	135557

2" ROUND - 48" OAL

ITEM	START DIA	END DIA	NO. TEETH	LBS	PN
918-AR-48	9"	18"	8	150	135578
1224-AR-48	12"	24"	9	155	135579
1530-AR-48	15"	30"	11	250	135580
1836-AR-48	18"	36"	13	285	135581

BoRH[®] FOR AGGRESSOR

Pengo's patented BoRH[®] (Bolt on Rock Head) provides the ultimate solution for all your drilling applications. Designed to convert a standard Aggressor Dirt Auger into a rock auger, the BoRH eliminates the need for an additional and dedicated Rock Auger. The BoRH kit contains our boring head, pilot bit, wear caps, bullet-style carbide teeth and all hardware needed to complete the installation. Featuring innovative wear caps and enlarged shoulders on the teeth for increased wear, the BoRH system provides the ultimate solution across a wide variety of soil conditions.

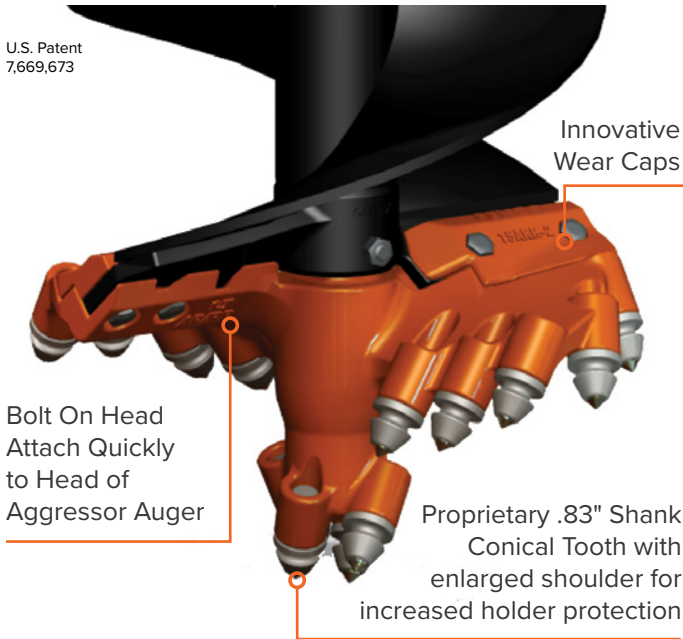

U.S. Patent
7,669,673

Innovative
Wear Caps

Bolt On Head
Attach Quickly
to Head of
Aggressor Auger

Proprietary .83" Shank
Conical Tooth with
enlarged shoulder for
increased holder protection

DRILLING SOIL CONDITIONS

HIGHLY RECOMMENDED



GRAVEL

FRACTURABLE
ROCK

BoRH 6"-24"

ITEM	DIA	NO. TEETH	LBS	PN
6-BORH	6"	8	24	137991
9-BORH	9"	10	36	137992
12-BORH	12"	12	43	137993
15-BORH	15"	14	47	137994
18-BORH	18"	16	56	137995
24-BORH	24"	20	79	137996

CONICAL TOOTH



P21-RR

The Pengo S21-RR Tooth was designed exclusively for the Pengo BoRH (Bolt-on Rock Head) which converts the Pengo Aggressor auger into a rock auger in minutes. The stout S21-RR design works well in hard rock and concrete conditions and the enlarged tooth shoulder helps to protect the BoRH from wear.

TOOTH REMOVAL PULLER



C123 Puller

Easy as 1-2-3!

Use the C123 Puller for easy removal of the P21 RR tooth

ITEM	LBS	PN	SOIL
P21 RR	.59	137990	 

ITEM	LBS	PN
C123	3	134091

AGGRESSOR® PARTS

TRIFLOW® 350 PILOT BITS



TF-350



TF-350HF



TF-350CXC



TF-350HFTC



TF-350C



HEX BOLT

ITEM	LBS	PN	SOIL
TF-350	5	135088	1 2 3
TF-350HF	5.5	135089	2 3 4
TF-350CXC	5.8	135091	2 3 4 5
TF-350HFTC	5.5	135092	2 3 4
TF-350C	5.5	135090	4 5
3.5" Hex Bolt 6" - 9" Dia.	-	1098	-
4" Hex Bolt 12"+ Dia.	-	1100	-
Hex Nut Lock	-	134527	-

AUGER STAND

Storage Auger Stand for Aggressor Augers

For convenient storage of your Pengo 2" Aggressor augers, we have designed a simple metal base with a 2" Hex connection, that your auger can slip easily onto. Thus giving you a safe and out-of-the-way storage option.

LBS	PN
14	135102



40/50 TEETH



40/50 TOOTH



40/50HFF TOOTH



40/50C TOOTH

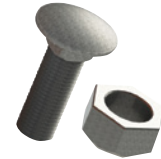

NUTS & BOLTS

ITEM	LBS	PN	SOIL
40/50	.5	134501	1 2 3
40/50HFF	.5	134802	2 3 4
40/50C	.65	134519	4 5
Carriage Bolt	-	1872	-
Hex Nut Lock	-	134527	-

Aggressor auger teeth are for use in dirt, abrasive soil or fracturable rock, depending on the type of tooth you are using. All types of the 40/50 tooth can be used at either a 40° or 50° angle providing different attack angles based on your drilling condition.

40° Angle

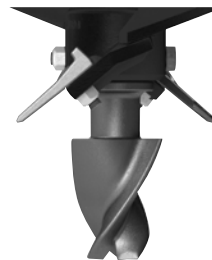

50° Angle

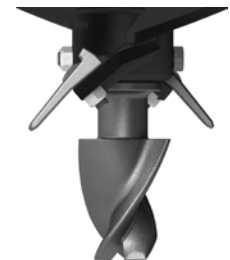

TRIMAX[®] AUGER

Pengo's TriMax[®] auger is designed to handle your most challenging applications across a variety of drilling conditions. Available in both single and double flight configurations, the TriMax features our TriFlow[®] Pilot, which provides unmatched stability and wear characteristics. Combined with our Fas-N-Lok[®] teeth and cast head with compound angles; dirt, sand, silt or gravel are no match for the TriMax.

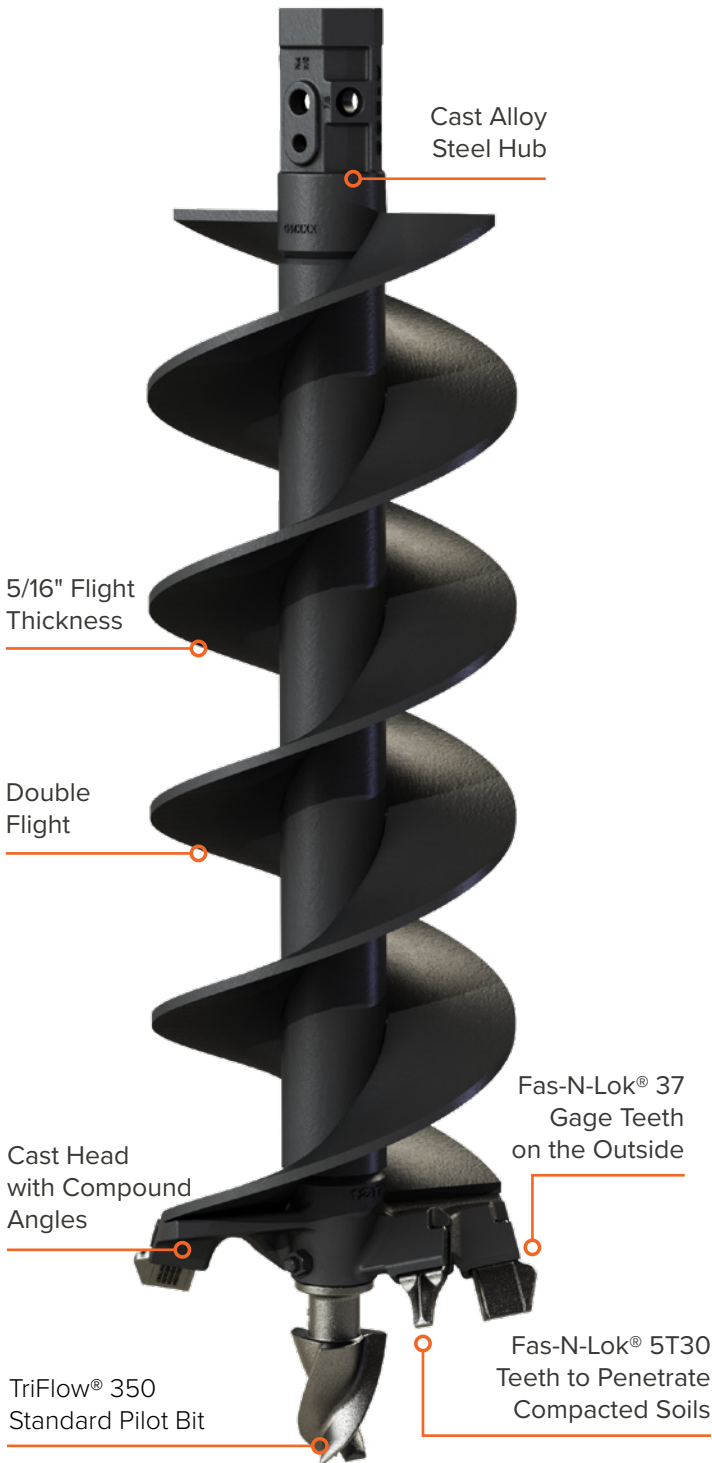

DRILLING SOIL CONDITIONS

RECOMMENDED

HIGHLY RECOMMENDED

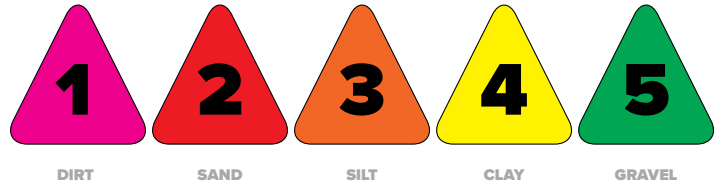

2" HEX - 48" OAL

ITEM	DIA	NO. TEETH	LBS	PN
6-TM-48-D	6"	2	62	104091
9-TM-48-D	9"	4	78	104093
12-TM-48-D	12"	4	106	104095
16-TM-48-D	16"	6	100	104097
18-TM-48-D	18"	6	124	104098
24-TM-48-D	24"	8	166	104100
30-TM-48-D	30"	10	207	104101
36-TM-48-D	36"	12	270	104102
48-TM-48-D	48"	18	375	104104

2 1/2" HEX - 48" OAL

ITEM	DIA	NO. TEETH	LBS	PN
6-TM-48-D	6"	2	77	243230
9-TM-48-D	9"	4	91	243231
12-TM-48-D	12"	4	95	243232
16-TM-48-D	16"	6	136	243233
18-TM-48-D	18"	6	187	243234
24-TM-48-D	24"	8	171	243235
30-TM-48-D	30"	10	228	243236
36-TM-48-D	36"	12	269	243237

2 9/16" ROUND - 48" OAL

ITEM	DIA	NO. TEETH	LBS	PN
6-TM-48-D	6"	2	61	104108
9-TM-48-D	9"	4	77	104110
12-TM-48-D	12"	4	105	104112
16-TM-48-D	16"	6	99	104114
18-TM-48-D	18"	6	123	104115
24-TM-48-D	24"	8	165	104117
30-TM-48-D	30"	10	206	104118
36-TM-48-D	36"	12	269	104119

Single flight Trimax models available.
Speak to your local representative for more information

TRIMAX® PARTS

TRIFLOW® 350 PILOT BITS



TF-350



TF-350HF



TF-350CXC



TF-350HFTC



TF-350C



HEX BOLT

ITEM	LBS	PN	SOIL
TF-350	5	135088	1 2 3
TF-350HF	5.5	135089	2 3 4
TF-350CXC	5.8	135091	2 3 4
TF-350HFTC	5.5	135092	2 3 4
TF-350C	5.5	135090	4 5
3.5" Hex Bolt 6" - 9" Dia.	-	1098	-
4" Hex Bolt 12"+ Dia.	-	1100	-
Hex Nut Lock	-	134527	-

ACCESSORIES



Soft Hammer

For easy installation of Fas-N-Lok® teeth use a soft hammer to prevent breaking of tips.



Drift Punch

For Easy Removal of Teeth Use this Drift Punch

ITEM	LBS	PN
Soft Hammer	3.5	137737
Drift Punch	1	137750

FAS-N-LOK® TEETH



1336L



35HF



35HFF



35C



RB-5T30



5T30



5T30C

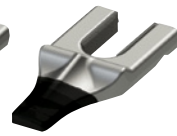

5T30HF



RB-36L



37

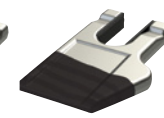

37F

ITEM	LBS	PN	SOIL
35	.4	133835	1 2 3
5T30	.4	140029	1 2 3
37	.5	140027	1 2 3
37F	.6	140010	2 3 4
35 HF	.6	140008	2 3 4
35 HFF	.6	140009	2 3 4
5T30 HF	.4	140014	2 3 4
35 C	.4	140007	4 5
5T30 C	.4	140012	4 5
1336L	.6	140016	4 5
RB-5T30	.4	140013	4 5 6
RB-36L	.6	140021	4 5 6

HOLDERS



T-35

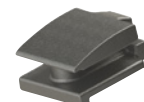

T-36

ITEM	LBS	PN
T-35	1	171221
T-36	1	171231

SEVERE ROCK RIPPER® AUGER

Pengo's Severe Rock Ripper® (SRR) is specifically designed to handle the most difficult rock applications. Featuring our Rock Ripper® Pilot, 1/2" thick hard faced flighting, and carbide conical teeth; the SRR is the most robust tool in the GP line-up. Our SRR can also be equipped with our Strata series of teeth, which provides drilling grade carbide and maximizes both performance and drilling efficiencies

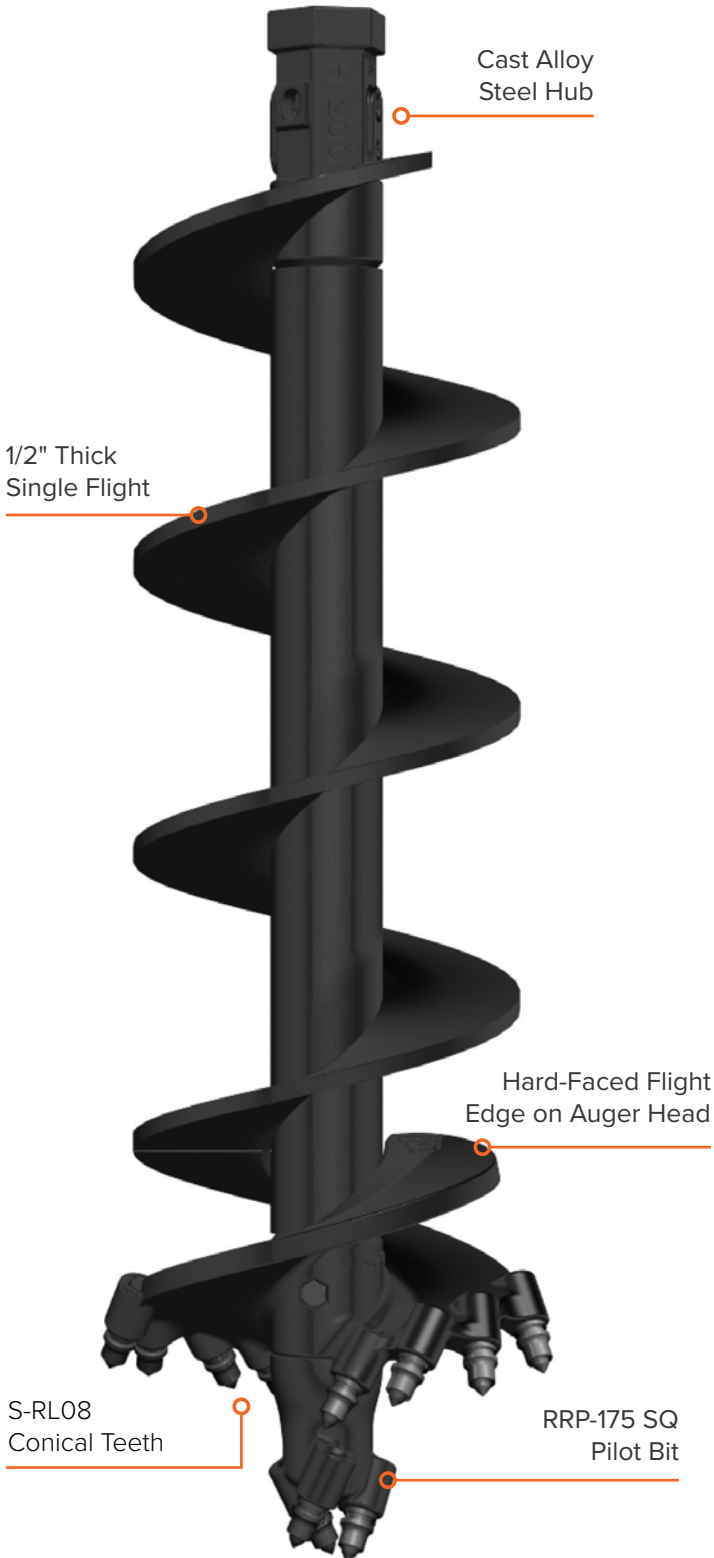

DRILLING SOIL CONDITIONS

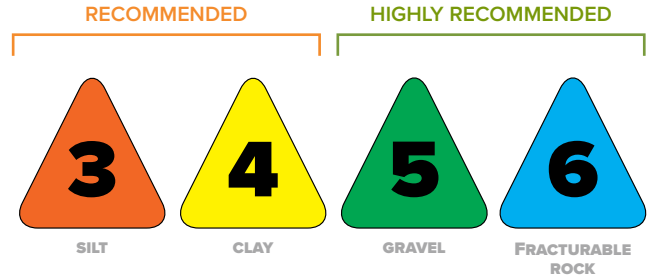

2" HEX - 48" OAL

ITEM	DIA	NO. TEETH	LBS	PN
6-SRR-48	6"	8	80	137950
9-SRR-48	8"	10	108	137951
12-SRR-48	12"	12	130	137952
16-SRR-48	16"	15	170	137953
18-SRR-48	18"	16	192	137954
24-SRR-48	24"	20	285	137956
30-SRR-48	30"	24	345	137957
36-SRR-48	36"	26	415	137958

The SRR Auger comes standard with the S-RL08 conical teeth. Replace with SR-76SW Strata® conical teeth for increased performance and life-cycle.

SEVERE ROCK RIPPER® PARTS

PILOT BITS



RRP 1.75 SQ

ITEM	LBS	PN	SOIL
RRP 1.75 SQ	15	137208	 

Nuts and bolts included.
Use 1.75SQ adapter - PN 137203.
When purchased individually, this pilot is ships with four Strata® SR-76SW teeth,

CONICAL TEETH







S-RL08 Standard Rock Tooth
For hard rock applications

SR-76SW Strata® Carbide Teeth
Drilling Grade Carbide Rock Tooth provides longer tooth life in extreme hard drilling conditions



P-10 Pocket
.86 Shank pocket for S-RL08 and

ITEM	LBS	PN	SOIL
S-RL08	.7	PNG990021	 
SR-76SW	.7	780001	 
P-10	.8	PNG990043	-

ACCESSORIES



Soft Hammer

STRATA® Conical teeth are made with a fragile carbide tip. Pengo® strongly recommends using a Soft Hammer when installing STRATA® teeth.

C30 Puller

Due to the enlarged shoulder of the SR-76SW Strata® Tooth, the C30 Puller is recommended to aid in removing the tooth.



C123 Puller

The S-RL08 Teeth will need the C123 Puller for removal.



ITEM	LBS	PN
Soft Hammer	3.5	137737
C30 Puller	3	134090
C123 Puller	3	134091

GP AUGER EXTENSIONS

At times there is a need for a little more depth. Couple your Pengo auger with a Pengo extension to get the job done. We offer a wide variety of extensions from fixed to telescoping with round and hex connections. Whatever your need, contact a Pengo sales team member to determine the best option for your job.

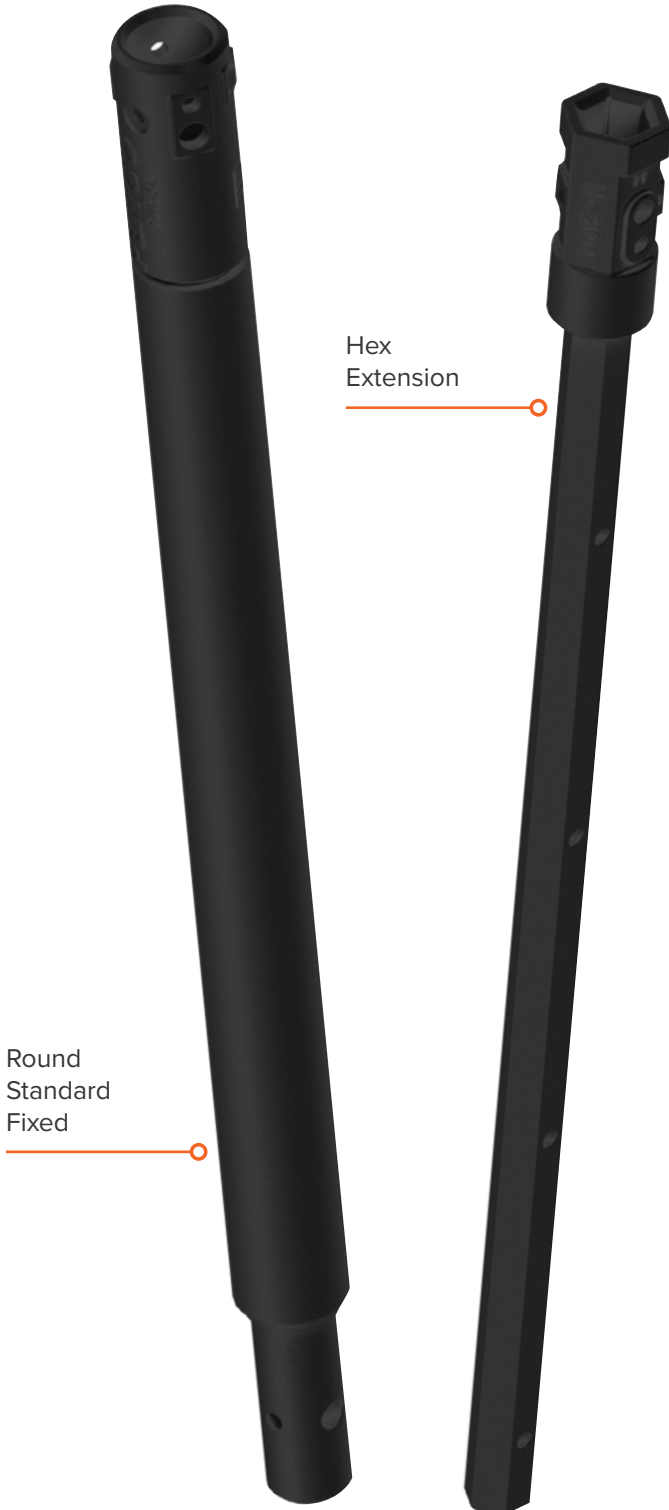

Hex
Extension

Round
Standard
Fixed

TELESCOPING EXTENSIONS

2" HEX

ITEM	DIMS	LBS	PN
HE20-12 STANDARD	H200 x 12"	22	557142
HE20-24 STANDARD	H200 x 24"	34	557143
HE20-36 STANDARD	H200 x 36"	46	557144
HE20-48 STANDARD	H200 x 48"	58	557145
HE20-60 STANDARD	H200 x 60"	69	557146

FIXED EXTENSIONS

2" ROUND

ITEM	DIMS	LBS	PN
RE20-12 STD FIXED	R200 x 12"	20	557176
RE20-24 STD FIXED	R200 x 24"	31	557178
RE20-36 STD FIXED	R200 x 36"	40	557174

2 9/16" ROUND

ITEM	DIMS	LBS	PN
RE25-12 STD FIXED	R256 x 12"	20	134203
RE25-24 STD FIXED	R256 x 24"	31	134204
RE25-36 STD FIXED	R256 x 36"	40	134205
RE25-48 STD FIXED	R256 x 48"	50	134206
RE25-60 STD FIXED	R256 x 60"	61	134207

GP AUGER HUBS AND HUB ADAPTERS

REPLACEMENT HUBS



ITEM	DIMS	LBS	PN
R-200	2" ROUND CAST	5.2	154080
R-256U	2 9/16" UNIVERSAL	9.5	154115
H-200U	2" HEX UNIVERSAL	10.5	154121

HUB ADAPTERS

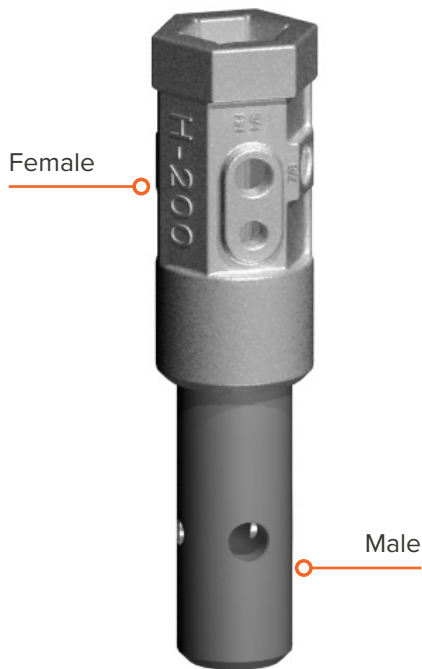

FEMALE HEX

ITEM	DIMS	LBS	PN
H-200F X R256M	2" Hex Female x 2 9/16" Round Male	20	134211
H-200F X R-200M	2" Hex Female x 2" Round Male	14	557156
H-250F X H-200M	2 1/2" Hex Female x 2" Hex Male	30	132419
H-225F X H-200M	2 1/4" Hex Female x 2" Hex Male	20	557159

FEMALE ROUND

ITEM	DIMS	LBS	PN
R-200F X H-200M	2" Round Female x 2" Hex Male	13	132804
R-200F X R-256M	2" Round Female x 2 9/16" Round Male	15	134210
R-256F X H-250M	2 9/16" Round Female x 2 1/2" Hex Male	21	133906
R-256F X R-200M	2 9/16" Round Female x 2" Round Male	13	132068
R-256F X S-200M	2 9/16" Round Female x 2" Square Male	19	557155
R-256 X H-200M	2 9/16" Round Female x 2" Hex Male	18	557153

**SELECTION.
INNOVATION.
PERFORMANCE.**



 **PENGO**[®]